

A/C UNITS THAT SET ON A CONCRETE OR ASPHALT LOT WILL HAVE A CAGE WITH FLAT PLATES WELDED TO EACH CORNER AND FASTENED W/TAP CONS.

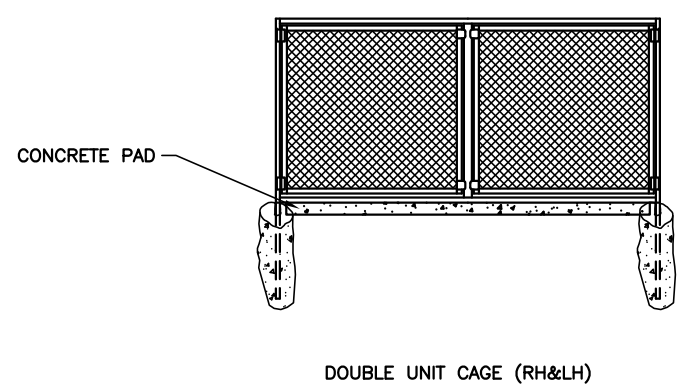

A/C UNITS THAT SET ON A CONCRETE PAD WILL HAVE A CAGE WITH 2'-0" LONG LEGS ON EACH CORNER AND WILL BE MOUNTED IN CONCRETE.

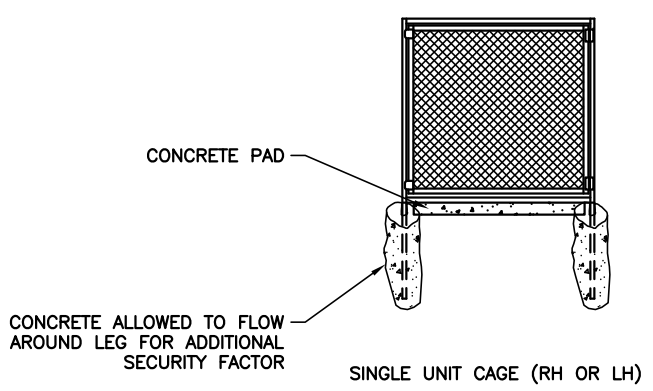
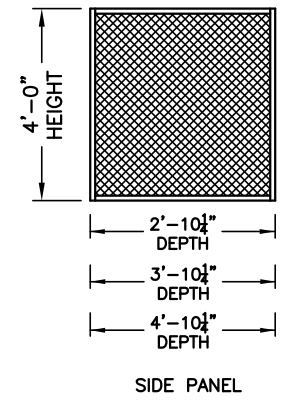
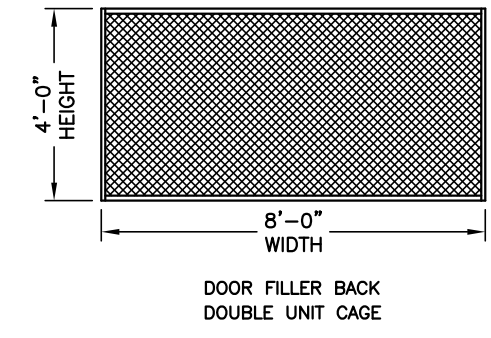
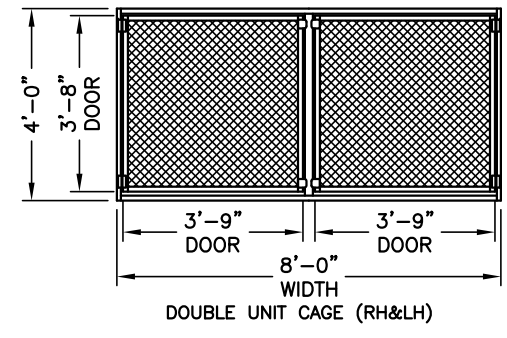
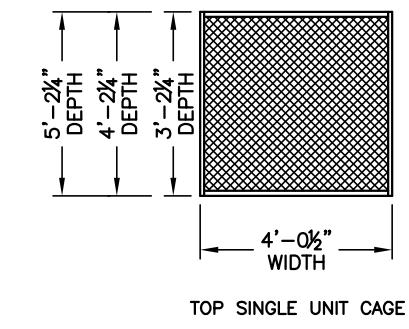
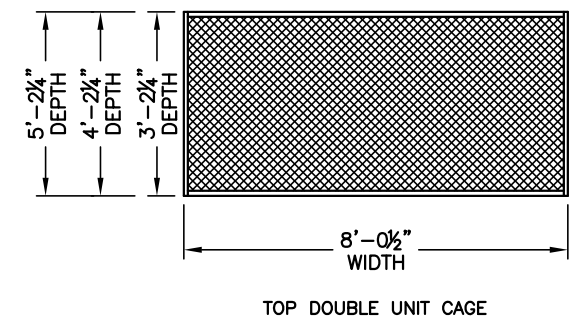

SPECIFICATIONS

DOOR FRAME, BACK, TOP, AND SIDE PANELS
 CONSTRUCTED OF 1" x 1-3/4" x 1" 14ga FORMED CHANNEL, 1-1/4" x 1" 14ga FORMED ANGLE AND 1-1/2" No. 13 FLATTENED EXPANDED METAL WITH ALL BURRS REMOVED.

DOOR HINGES
 3" x 3" TIGHT PIN BUTT HINGES

DOOR STOPS AND PADLOCK HASPS
 STOPS OF 1" x 12 GA FLAT BAR; HASPS FORMED OF 12ga STEEL ANGLE WITH ALL EXPOSED CORNERS ROUNDED.

FASTENERS
 5/16" SELF-DRILLING FASTENERS CONNECTING DOOR FRAME TO PARTITION.

FINISH
 DOORS, FRAMES, PARTITIONS AND TOPS FINISHED WITH "NO MAR" POLYESTER POWDER COAT IN MACHINERY GRAY (UNLESS OTHERWISE INDICATED).

PLEASE CHECK TO VERIFY COLOR CHOICE:

- BLACK
- GRAY
- FOREST GREEN
- SANDLEWOOD

SUBMITTAL
 DO NOT BUILD

Valiant Products, Inc. P.O. Box 405 • Lakeland, FL 33802		PH. (863) 688-7998 FAX (863) 683-9749 LICENSE #CS C033741	
TITLE: SAMPLE DRAWING		PROJECT: A/C SECURITY CAGE	
SIGNATURE		DATE	
DRAWN: RMJ		24FEB09	
CHK'D:		DRAWING NO.	
APV'D:		REV. —	
SCALE: 1/4" = 1'		DO NOT SCALE DRAWING	
		SHEET 1 of 1	